

Pulsair **intelliPuff**

Instructions for use



Keeler

Next ▶

Contents

1. Copyright and Trademarks.....	p3	10. Measurement procedures	p15
2. Introduction	p4	10.1 Preparing the device	p15
3. Symbols	p5	10.2 Preparing the patient.....	p16
4. Safety.....	p6	10.3 Taking the reading	p17
4.1 Device Classification	p6	11. Display examples	p19
4.2 Warnings and cautions	p6	12. Printing	p20
5. Cleaning instructions.....	p7	13. Replacing the printer paper	p21
6. Power supply assembly	p8	14. User menu options	p22
7. Wall mounting.....	p9	15. Calibration, maintenance and inspection.....	p23
8. Tonometry pressure variations in the human eye	p10	16. Specifications and electrical ratings	p25
9. Names of controls and components	p11	17. Accessories and warranty.....	p31
		18. Contact, packaging and disposal information	p32

Please click on the contents to go straight to your chosen section or navigate by using the 'Next' and 'Back' buttons to the right. Clicking on 'Home' will bring you back to this page.

Keeler

1. Copyright and Trademarks

The information contained within this manual must not be reproduced in whole or part without the manufacturer's prior written approval.

The manufacturer reserves the right to make changes to specifications and other information contained in this document without prior notice.

Pulsair IntelliPuff™ is a registered Trademark of Keeler Limited 2007.

Copyright © Keeler Limited 2007.

Published in the UK 2009.

Description of the product

The Pulsair IntelliPuff Non-Contact Tonometer is indicated for measuring intraocular pressure without contacting the eye to aid in the screening and diagnosis of glaucoma.

It is an "air puff" Tonometer designed to accurately measure Intra Ocular Pressure (IOP) without making contact with the surface of the eye.

Air impulse tonometry is a variant of the general applanation tonometry in which a portion of the cornea is flexed by mechanical stimuli in which the force/pressure required to produce the flexing effect is related to the intraocular pressure.

The air puff technique requires directing a calibrated quantized packet of air towards the central portion of the cornea, and the detection of the pre-defined deformation of the cornea through optical means and reflections from the corneal surface.

Please read and follow these instructions carefully.

Keeler

2. Introduction

Thank you for purchasing the Keeler Pulsair
intelliPuff™.

The product has been designed and manufactured to
ensure that you will enjoy many years of
trouble free and safe use.

Please follow the User Instructions to
ensure optimum performance.



Keeler

3. Symbols



Read user instructions for Warnings, Cautions and additional information



The CE mark on this product indicates it has been tested to and conforms with the provisions noted within the 93/42/EEC Medical Device Directive



Double insulated



Type BF protections against shock



Consult instructions for use



Manufacturers name and address



Keep dry



Power input port



On/Off



Fragile



This way up



Material suitable for recycling

4. Safety

4.1 Device Classification

CE Regulation 93/42 EEC: Class 2a

FDA: Class II

4.2 Warnings and cautions



- Do not use if the product is visibly damaged and periodically inspect for signs of damage.
- Do not use in the presence of flammable gases.
- This product should not be immersed in fluids.
- Do not fit mains power adapter into a damaged mains outlet socket.
- Route power cords safely to eliminate risk of tripping or damage to user.
- USA Federal law restricts this device to sale by or order of a physician.
- Only use approved Keeler power supply EP29-32777 or instrument may malfunction.

- Do not remove the labels covering the key holes unless wall mounting the Pulsair intelliPuff.



- The product has been designed to function safely when at an ambient temperature between +10°C and +35°C.
- This product should be used in a room with subdued lighting.
- Keep out of the reach of children.
- Accuracy of IOP measurements is known to be affected by variations and changes in corneal rigidity due to differences in corneal thickness, intrinsic structural factors or corneal refractive surgery. It is recommended that these factors are considered during IOP measurement.
- To prevent condensation from forming, allow instrument to come to room temperature before use.
- Only mount on wall according to Keeler Instructions.
- Before using the Pulsair intelliPuff, press the Demo button to dispel any minute particles of dust.

Keeler

5. Cleaning instructions

Only manual non-immersion cleaning as described should be used for this instrument. Do not autoclave or immerse in cleaning fluids. Always disconnect power supply from source before cleaning.

- a Wipe the external surface with a clean absorbent, non-shedding cloth dampened with a water / detergent solution (2% detergent by volume) or water / isopropyl alcohol solution (70% IPA by volume). Avoid optical surfaces.
- b Ensure that excess solution does not enter the instrument. Use caution to ensure cloth is not saturated with solution.
- c Surfaces must be carefully hand-dried using a clean non-shedding cloth.
- d Safely dispose of used cleaning materials.

6. Power supply assembly

Set Plug

Replace the blanking plate with the appropriate mains plug adapter if required, or use IEC 60320 TYPE 7 connector (not supplied).

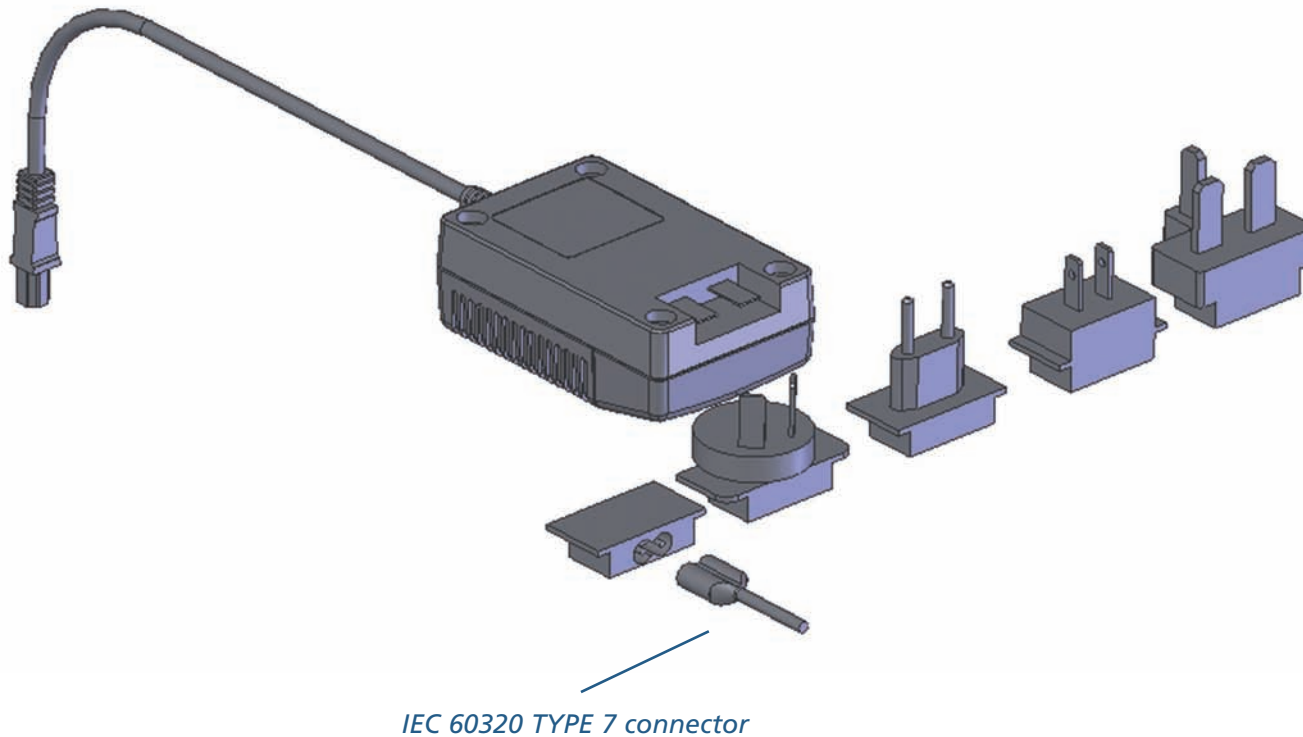

7. Wall mounting

Your Pulsair IntelliPuff is supplied with a sturdy wall mounting bracket.

1. The bracket has four holes allowing it to be securely fixed to an appropriate wall or vertical surface.
2. Choose carefully the intended location for your IntelliPuff with particular consideration to health and safety aspects, for example the routing of the power lead, and its position in regard to the user and the patient.
3. Use the wall mounting bracket as a template and clearly mark the position of the holes in the wall. Ensure that there are no live utilities where you are to drill.
4. Drill the appropriate size holes for the screws and rawplugs supplied.
5. Attach the plate securely to the wall.
6. Remove labels covering the key holes.
7. Carefully locate the mounting pegs of the plate to the key holes on the back of your Pulsair IntelliPuff and allow the Pulsair be lowered into its final and secure position.

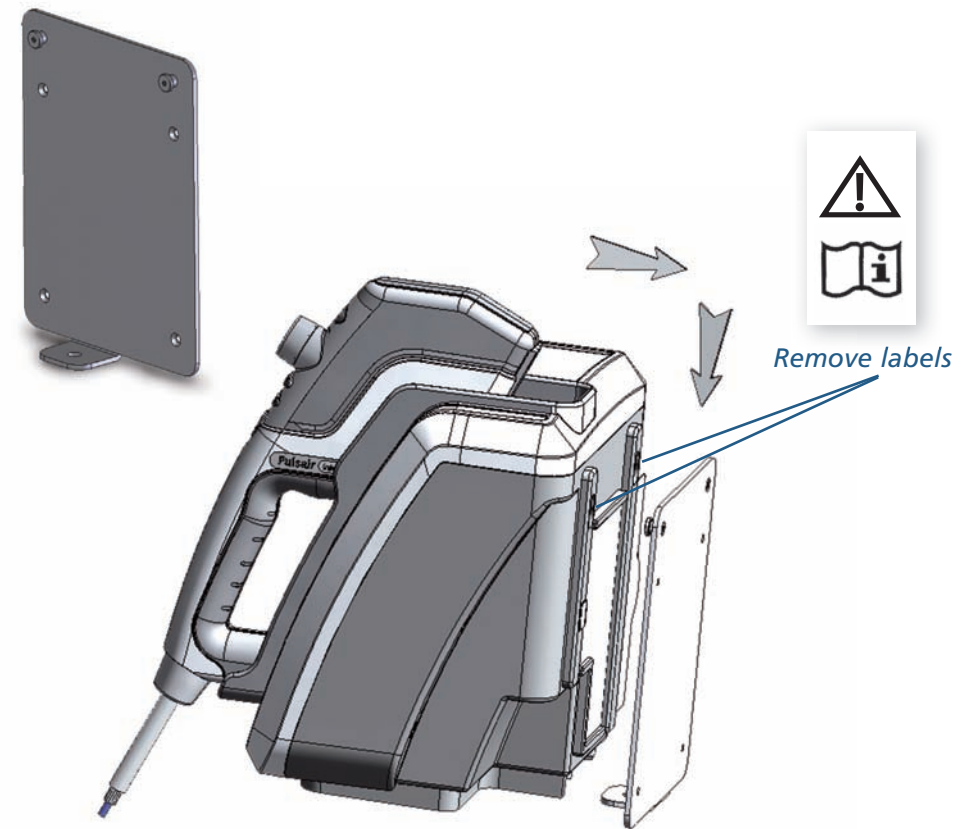

8. Tonometry, pressure variations in the human eye

The Keeler Pulsair intelliPuff measures intra-ocular pressure by automatically releasing a gentle puff of air onto the cornea. This is known as an event.

An single reading can sometimes be misleading as the IOP will vary as a result of pulse, respiratory and diurnal fluctuations. In addition blinking, squeezing, fluid intake, physical activity, body position and even the direction of gaze can influence IOP.

Up to 4 readings may be required in order to reduce the impact of these variants to a constant IOP.

Pulsair intelliPuff software will recognise the readings and give a sound notification when two consecutive readings are ± 1 mmHg of each other indicating that further measurements may not be required.

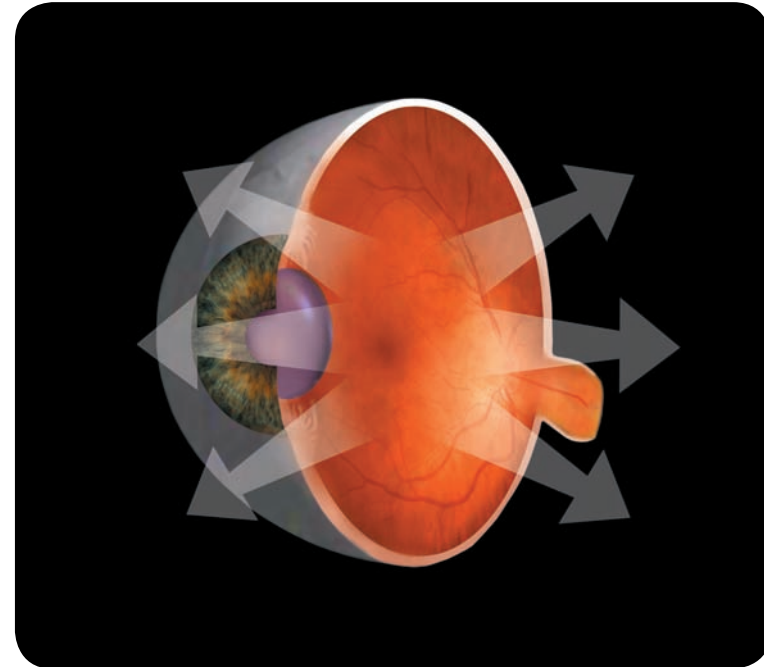

9. Names of controls and components

1. On off push button

To turn the IntelliPuff on, push the on off button – a green LED will indicate the unit is on.

To turn off the IntelliPuff, push the on off button – the green LED will go out.

2. Test eye

This is useful for user training; it will not return an IOP measurement.

3. Printer active LED

When lit, this indicates the printer is activated; replacing the handset in the cradle will force a print. Alternatively a print can be forced at any time using the print button on the handset.

4. Printer cover

Access to the printer paper is via this cover, use your finger in the lip on the top of the cover and gently pull towards you to open the printer cover.

5. Serial port

The serial port is used for calibration, systems checking and data output (located on rear of instrument).

6. Power input

Insert the low voltage power lead (located on rear of instrument) use only Keeler power supplies.

7. Forehead rest

Push to release, or push to return the forehead stabiliser to its discrete position.

8. Right (OD) / Left (OS) indicators

These will indicate the eye to be measured; the OD/OS button will toggle between these indicators.



Keeler

9. Names of controls and components

9. Display

The display shows the recorded IOP reading and the averaged IOP reading.

After the first reading is taken the display shows the measured IOP. After each of the consecutive reading is taken the display shows the average of the readings taken so far, i.e. the first figure displayed is the actual reading, the second figure is an average of the first two readings etc., up to a maximum of 4 readings per eye.

Note: *The displayed figure is rounded to the nearest whole number or displayed to one decimal place depending on the user setting accessed via the menu.*

The displayed average is based on the readings which are taken to one decimal place. For example, readings of 15.4, 16.3, 14.2 and 16.9 are averaged by adding them together which equals 62.8 and dividing by the number of readings taken, 4. This gives a final figure of 15.7, or 16 depending on user settings.

When all the required readings have been taken the figure displayed is the IOP that is recorded for the patient.

When two consecutive readings are within 1mmHg an audible sound will be heard indicating that sufficient readings may have been taken.



Keeler

9. Names of controls and components

Main control buttons

10. Print / Menu button

A press of less than one second will print the acquired data; press and hold for more than 3 seconds to access the user menu and sub menu functions. Refer to page 22 for full instructions on the user menu options.

11. Review button / Easy pulse button

The 'R' review button is dual function:

- Review → It allows the reader to review readings taken.
- Easy Pulse mode → In the event of difficulties in firing, for example with a damaged or scarred cornea, it will override the firing parameters to ease taking the measurement.

Press the Review button. The display shows the readings taken in the order they were taken, the final figure displayed is the cumulative average, the IOP.

The Pulsair memory retains a rolling four readings, per eye. New readings automatically replace the oldest.

To review the other eye, press the OD/OS button once and then press the review button.

To clear the memory you can either replace the hand unit in the holster and remove again or press the Demo button.

To initiate Easy Pulse mode hold the review button for greater than one second; the display will show 'easy', it will beep once and the unit will be ready to use on the difficult eye. Pressing any button, returning the handpiece to the cradle or performing a manual reset by pressing the button in the cradle well will return the IntelliPuff to its previous settings.



12. Demo button

In order to reassure the patient, you can demonstrate the procedure, using the Demo button, on the back of the patient's hand prior to taking a reading.

13. OD / OS button 'Menu Change button'

This toggles between recording data for the left or right eyes. This button also is used to toggle through the menu options when in menu mode, refer to page 22 for full instructions on the user menu options.

14. Eyepiece

The Eyepiece allows the user to view the patient's eye and align the targeting system.

Keeler

9. Names of controls and components

15. Puff tube and lens

The puff tube and puff lens is the part of the Pulsair IntelliPuff through which the Pulsair is aligned and a gentle puff of air is emitted.

16. Alignment LEDs

The two green LED's located on the front of the hand unit act as a guide when you are lining up the patient's eye to take a reading.



10. Measurement procedures

10.1 Preparing the device

1. Plug in the power supply cord to the instrument. The power socket is located at the rear of the instrument.
2. Turn the instrument on using the on/off push switch located on the front of the instrument.
3. Lift the handpiece from the cradle.
4. Remove the red protective dust cap from the puff tube.
5. When the hand unit is removed from the holster the two green LED's on the front illuminate, and the pump starts, the intelliPuff will perform a system check, when complete the display will read 'OK', refer to section 13 for a full list of display data.
6. Before using the Pulsair intelliPuff press the Demo button to dispel any minute particles of dust or moisture which may have settled whilst the Pulsair intelliPuff was not in use.

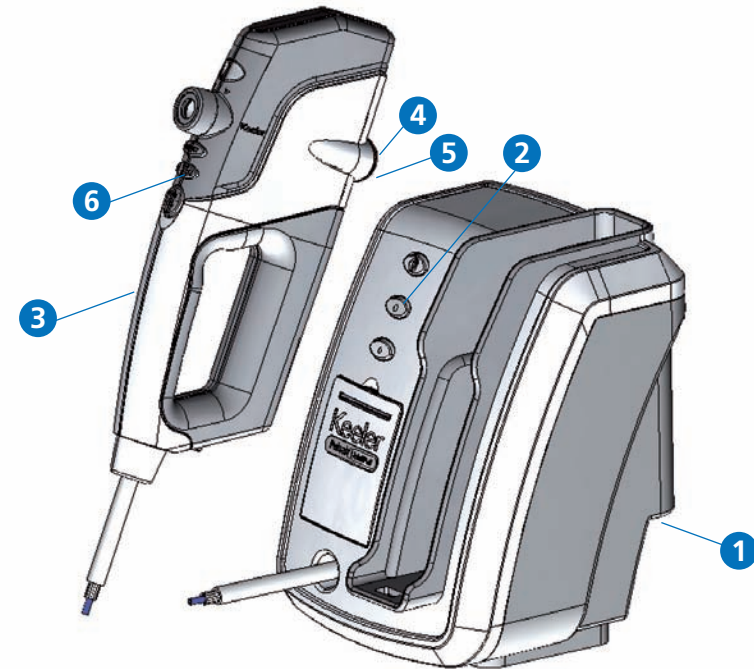

10. Measurement procedures

10.2 Preparing the patient

Before using the Pulsair IntelliPuff you should make your patient feel at ease and ensure they are located in an optimum reading location, preferably with their head supported. This is because apprehension and nervousness may adversely affect the readings obtained. Follow the points outlined below to achieve this:

1. Ensure that the patient is comfortable and in a relaxed position.
2. Ask the patient to remove their contact lenses or spectacles if worn and to blink and breathe normally.
3. In order to reassure the patient, you can demonstrate the procedure, using the Demo button, on the back of the patient's hand prior to taking a reading.

Before taking a reading you should:

1. Ask the patient to blink to ensure a good and reflective tear film.
2. Ensure the patient and instrument optics are not positioned under direct lighting (i.e. spot lights or sunlight).
3. Ensure the patient's eyes are fully opened. This helps to prevent squeezing, where the patient unconsciously tenses their eyelids and increases IOP.
4. Throughout the reading process, you should:
Allow the patient to blink at intervals in order to maintain the corneal tear film.

10. Measurement procedures

10.3 Taking the reading

Once the Pulsair IntelliPuff and the patient are prepared, you are ready to take a reading.

1. The Pulsair IntelliPuff is set to automatically select the right eye as the first eye to be measured. If you wish to select the left eye, press the OD/OS button on the hand unit.

2. Lift the hand unit, the pump starts and the two green LEDs illuminate.

3. From a distance of about 30 cms (12 inches), look through the eyepiece and locate the patient's eye.



4. Slowly move closer to the patient, maintaining alignment. Support the Pulsair IntelliPuff against your free hand and/or use the 'pop out' forehead stabilizer.



5. Continue to move in slowly towards the patient, two green dots appear.



6. Continue to move closer, a red reflex appears.



7. Move closer. At a distance of approximately 15mm, a black cross on red or 'bow tie' image appears. Centre this image (on the central bar) and the Pulsair IntelliPuff fires.



8. Once you have taken a reading, remain in the operating position; wait a few seconds for the air chamber to refill. When the 'bow tie' image appears Pulsair IntelliPuff takes a subsequent reading. When two successive readings within 1mmHg of each other are recorded, a sound may be emitted (if sounds are enabled in the menu settings). If successive readings of within 1mmHg of each other are not obtained, Keeler recommend taking up to four readings.

Continued on next page

Keeler

10. Measurement procedures

10.3 Taking the reading

9. When two consecutive readings are within 1mmHg an audible sound will be heard indicating that sufficient readings may have been taken.
10. If a reading is recorded as a non event or bad event, a bad event long high pitch tone will be heard.
11. The first reading will be the measured value; successive readings will display the running average IOP. Outlying or spurious readings will automatically be excluded from the calculation.
12. At any time the review button will allow you to view the individual readings.
13. If the unit does not fire, repeat step 3-7.

To measure the other eye, press the **OD/OS** button on the hand unit and repeat processes 3 - 7.

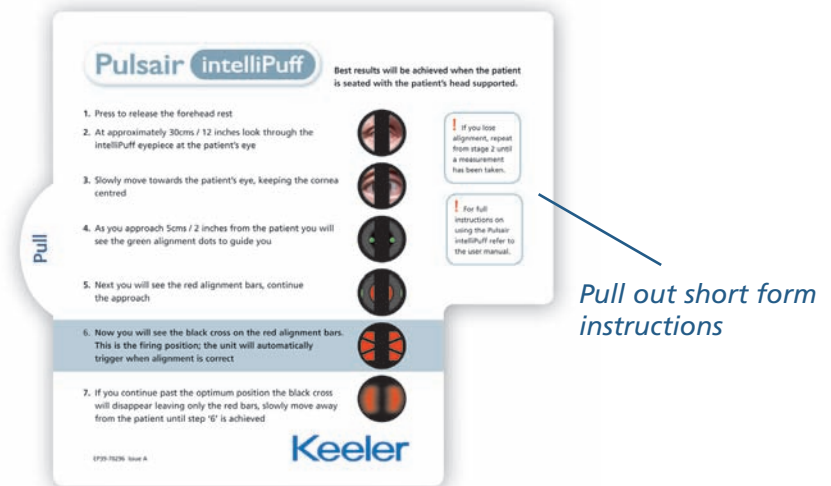

11. Display examples

The image shows the text 'STBY' in a green, seven-segment digital font on a black background.

The unit will display STBY when power is on.

The image shows the text 'WAIT' in a green, seven-segment digital font on a black background.

The unit will display 'wait' for one second while the system initialises.

The image shows the text 'OK' in a green, seven-segment digital font on a black background.

When no fault is found, OK is displayed and the unit defaults to measure the right eye OD.

The image shows the number '14' in a green, seven-segment digital font on a black background.

Shows first reading of 14mmHg.

The LED OD/OS indicator shows which eye the reading relates to.

The image shows the number '14.7' in a green, seven-segment digital font on a black background.

If 0.1 significant figure is selected using the menu options.

In this case there is no indication on the display that the reading is the first or average of more than 1.

The image shows the text '>25' in a green, seven-segment digital font on a black background.

When a pressure (IOP) of greater than 25mmHg is detected, the unit will display >25, the puff intensity will automatically be increased from the soft puff to the normal puff level for subsequent measurements.

The image shows the text 'RUN TEST' in a green, seven-segment digital font on a black background.

The unit will perform regular self tests – if a possible discrepancy in operating parameters is suspected the 'run self test' message will be displayed for up to 15 seconds. To continue to use the unit press the OD/OS button to clear the message. The results displayed thereafter may be suspect. Refer to the **user menu options** section in this manual for guidance on running the self test.

The image shows the text 'ERR' in a green, seven-segment digital font on a black background.

Display shows error.

(Signified by a long high pitch sound).

Keeler

12. Printing

The results can be printed by pressing the print button on the handpiece, or if the user menu is set to automatically print by replacing the handpiece in the cradle.

Sample print

The reading in brackets (20) indicates a discarded value (not taking into account in the average calculations).

The Name, Date and Time fields are to be manually written in by the operator.

The average IOP is printed to one decimal place 'xx.x'.

The last four individual readings are printed to zero decimal places 'xx'.

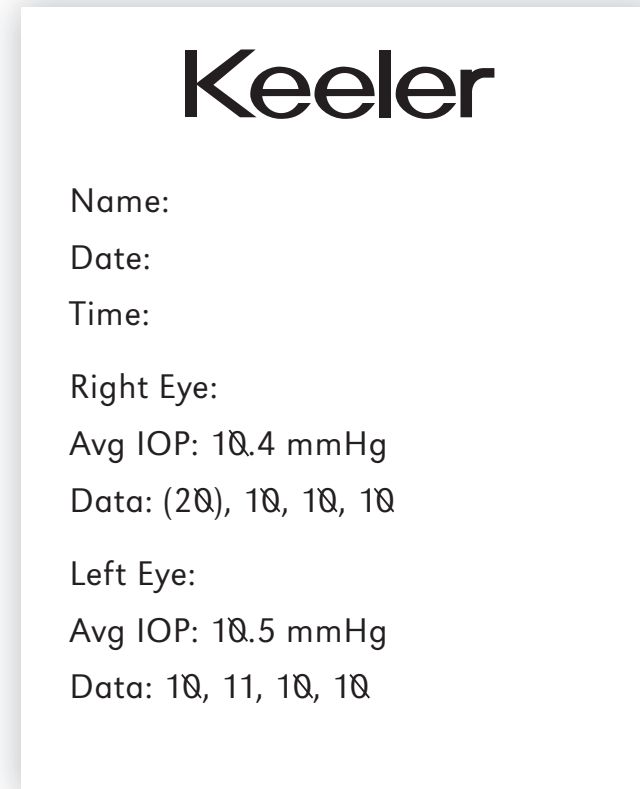

13. Replacing the printer paper

1. Access to the printer paper is via the printer cover, use your finger in the lip on the top of the cover and gently pull towards you to open the printer cover.

Remove the empty paper roll.

2. Place the new roll of paper into the paper holder, making sure the free end is loose at the top of the roll.
3. Feed the free end of paper through the gap in the cover.
4. Close the cover.

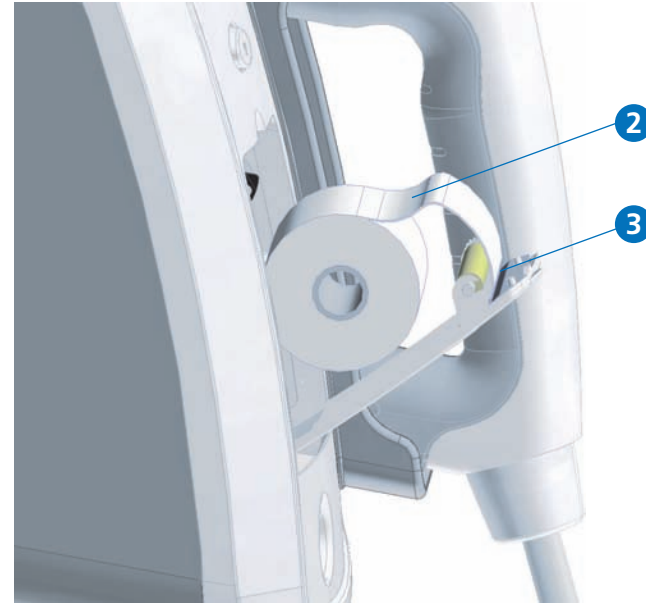

Keeler

14. User menu options

1. With the unit switched on and the handpiece removed, press and hold menu button for more than 3 second to enter the user menu.
2. The display will show the first user option and the current selection i.e. [prnt off] or [prnt on].
3. To change the user option, press the CHANGE button once, 'toggling' the CHANGE button will cycle through the option(s).
4. Pressing the MENU (print) button will move you forward to the next user option, in this case the buzzer control.
5. Use the CHANGE (OD/OS) button to make your preferred selection.
Note: to run the self test press the DEMO button, not the CHANGE button.
6. Continue to repeat steps 4 and 5 until 'OK' is displayed, your Pulsair intelliPuff is now ready to use with your preferred settings.

Menu option	Display	Change options
Printer control	PRNT	OFF / ON
Buzzer control	BUZ	ON / OFF
IOP Format	IOP:	XX / XX.X
Full self test	RUN	TEST/WAIT



15. Calibration, maintenance and inspection

Clean the puff tube lens on a weekly basis:

1. Moisten a cotton bud with Isopropyl Alcohol.
2. Move the tip of the bud around the lens in a circular motion.
3. After one circle the bud should be discarded to avoid smearing on the lens.
4. Look at the puff tube lens from the patient's side, if traces of tear film can still be seen, repeat above steps until clear.

Note: Care should be taken not to damage the Puff Tube assembly during cleaning.



Caution

Never use a dry cotton bud or tissue to clean the puff tube lens.
Never use a silicone impregnated cloth or tissue to clean the puff tube lens.

External cleaning

Keep the unit free of dust.



Regular inspection

Inspect your power supply unit and cable for damage regularly.

Before inspecting, disconnect the power supply from the Pulsair IntelliPuff and the mains.

If the outer insulation of the cable appears to be damaged discontinue use immediately. Contact your local dealer for a replacement.

Keeler

15. Calibration, maintenance and inspection

General

Keep the instrument free from dust.

If the unit is to remain unused for any length of time, turn the **On off push button** switch to **Off** and remove the power supply. Use the dust cover to protect the unit.

Servicing and calibration

Keeler recommends an annual calibration for the Tonometer. Do not modify this equipment without authorisation of the manufacturer.

This must be performed by an authorised Pulsair service centre or distributor. The unit performs a self function check when switched on and will indicate if a fault is found.

There are no user serviceable parts in this instrument. Service manuals will be available to authorised Keeler service centres and Keeler trained service personnel.

Keeler

16. Specifications and electrical ratings

Console dimensions	260 x 215 x 220mm (H x D x W)
Hand Unit dimensions	315 x 150 x 46mm (H x D x W)
Console weight	2.465Kg
Hand Unit weight	0.890Kg
Calibrated range	5mmHg to 50mmHg
Repeatability (Average coefficient of variation)	<5%
Accuracy	+/-5mmHg (95% confidence level*)
Displayed accuracy	Display accuracy to 1 decimal place e.g. 12.3
Working distance	20mm from surface of patient's cornea to front surface of first lens. This equates to a nominal distance of 15mm from the front of the puff tube shroud to the front surface of the patient's cornea
Displayed scale	4 character dot matrix scrolling
Illumination system	LED infra red
Length of umbilical cord	2 M

Complies with	Safety (Medical) EN 60601-1:1990 plus amendments A1:1993, A11:1993, A12:1993, A2:1995 and A13:1996. EN ISO 15004-1:2006, Clause 6.3 optical radiation hazard class 1, Clause 7.3 environmental conditions. EN60601-1-2 for EMC
Power Supply Unit	Switch mode, (110 – 240V)+/- 10% multi plug type compliant to EN 60601-1, EN 61000-6-2, EN 61000-6-3
Power supply output	30 VA (12V DC 2.5A)
Frequency	50/60 Hz
Environment	Use: +10°C to +35°C Storage: -10°C to + 55°C Transport: -15°C to + 60°C

** In a clinical study, the Pulsair IntelliPuff Tonometer appeared to slightly underestimate IOP relative to the Goldmann Tonometer at pressures above 30mmHg but these differences were not clinically significant.*

Keeler

16. Specifications and electrical ratings

It is well established that exposure of the eye to intense light sources for extended periods of time poses a risk of retinal photic injury. Many ophthalmic instruments illuminate the eye with intense light. The light levels on the Pulsair have been set at the lowest level possible.

No visible retinal lesions have been identified as a result of using Pulsair tonometers, however, young children and persons with diseased eyes may be at a higher risk. The risk may also be slightly increased if the person being examined has had any exposure with the same instrument or an other ophthalmic instrument using an intense visible light source during the previous 24 hours. This will apply particularly if the eye has been subjected to retinal photography.

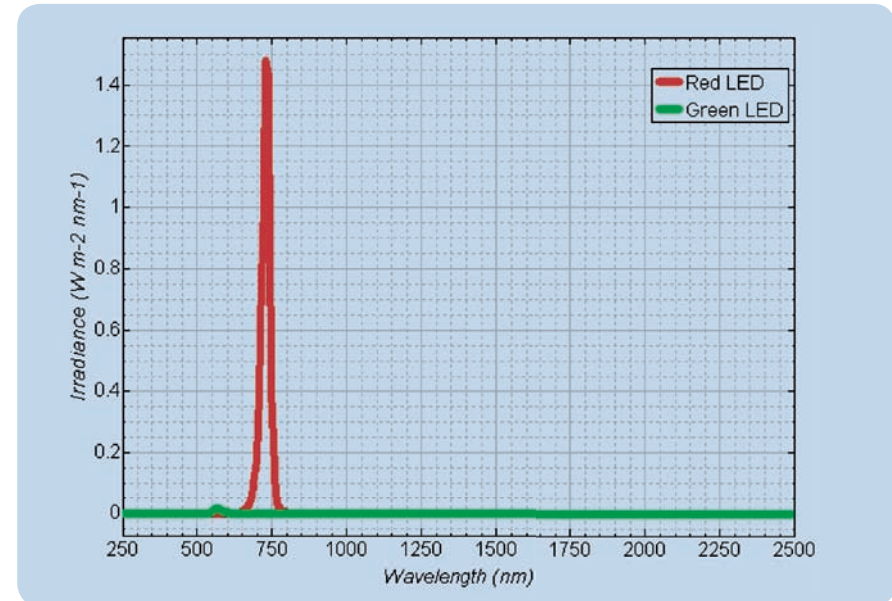

Figure 1: Spectral irradiance of instrument at user plane

Photochemical source radiance	Source	Radiance (mW cm ⁻² sr ⁻¹)
Aphakic, L _A (305-700nm)	Red LED	3.22
Phakic, L _B (380-700nm)	Red LED	3.20
Aphakic, L _A (305-700nm)	Green LED	<0.01
Phakic, L _B (380-700nm)	Green LED	<0.01

Table 2: Calculated photochemical source radiances

16. Specifications and electrical ratings

The Keeler Pulsair intelliPuff tonometer is a medical electrical instrument. The instrument requires special care concerning electromagnetic compatibility (EMC). This Section describes its suitability in terms of electromagnetic compatibility of this instrument. When installing or using this instrument, please read carefully and observe what is described here.

1. Portable or mobile-type radio frequency communication units may have an adverse effect on this instrument, resulting in malfunctioning.

Guidance and manufacturer's declaration – electromagnetic emissions

The Keeler Pulsair intelliPuff is intended for use in the electromagnetic environment specified below. The customer or user should assure that it is used in such an environment.

Emissions test	Compliance	Electromagnetic environment - guidance
RF emissions CISPR 11	Group 1	The Keeler Pulsair intelliPuff uses RF energy only for its internal function. Therefore, its RF emissions are very low and are not likely to cause any interference in nearby electronic equipment.
RF emissions CISPR 11	Class B	The Keeler Pulsair intelliPuff is suitable for use in all establishments including domestic establishments and those directly connected to the public low-voltage power supply network that supplies buildings used for domestic purposes.
Harmonic emissions IEC 61000-3-2	Class A	
Voltage fluctuations / flicker emissions IEC 61000-3-3	Complies	

16. Specifications and electrical ratings

Guidance and manufacturer's declaration – electromagnetic immunity

The Keeler Pulsair IntelliPuff is intended for use in the electromagnetic environment specified below. The customer or user should assure that it is used in such an environment.

Immunity test	IEC 60601 Test level	Compliance level	Electromagnetic environment - guidance
Electrostatic discharge (ESD). IEC 6100-4-2	± 6 kV contact ± 8 kV air	± 6 kV contact ± 8 kV air	Floors should be wood, concrete or ceramic tile. If floors are covered with synthetic material, the relative humidity should be at least 30%.
Electrical fast transient/burst. IEC 61000-4-4	± 2 kV for power supply lines ± 1 kV for input/output line(s)	± 2 kV for power supply lines ± 1 kV for input/output line(s)	Mains power quality should be that of a typical commercial or hospital environment.
Surge. IEC 61000-4-5	± 1 kV line(s) to line(s) ± 1 kV line(s) for line to earth	± 1 kV line(s) to line(s) ± 1 kV line(s) for line to earth	Mains power quality should be that of a typical commercial or hospital environment.
Voltage dips, short interruptions and voltage variations on power supply input lines. IEC 61000-4-11	<5% U_T (> 95% dip in U_T) 40% U_T (60% dip in U_T) for 5 cycles 70% U_T (30% dip in U_T) for 25 cycles <5% U_T (>95% dip in U_T) for 5 s	<5% U_T (> 95% dip in U_T) 40% U_T (60% dip in U_T) for 5 cycles 70% U_T (30% dip in U_T) for 25 cycles <5% U_T (>95% dip in U_T) for 5 s	Mains power quality should be that of a typical commercial or hospital environment. If the user of the Keeler Pulsair IntelliPuff requires continued operation during power mains interruptions, it is recommended that the instrument be powered from an uninterruptible power supply.
Power frequency (50/60 Hz) magnetic field. IEC 61000-4-8	3 A/m	3A/m	Power frequency magnetic fields should be at a level characteristic of a typical location in a typical commercial or hospital environment.

Note U_T is the a. c. mains voltage prior to application of the test level.

Keeler

16. Specifications and electrical ratings

Guidance and manufacturer's declaration – electromagnetic immunity

The Keeler Pulsair IntelliPuff is intended for use in the electromagnetic environment specified below. The customer or user should assure that it is used in such an environment.

Immunity test	IEC 60601 Test level	Compliance level	Electromagnetic environment - guidance
Conducted RF IEC 61000-4-6	3 Vrms	3 V	Portable and mobile RF communications equipment should be used no closer to any part of the Keeler Pulsair IntelliPuff, including cables, than the recommended separation distances calculated from the equation applicable to the frequency of the transmitter. Recommended separation distance $d = 1.2 \sqrt{p}$ $d = 1.2 \sqrt{p}$ 80MHz to 800 MHz $d = 2.3 \sqrt{p}$ 800MHz to 2.5GHz Where p is the maximum output power rating of the transmitter in watts(W) according to the transmitter manufacturer and d is the recommended separation distance in metres(m). Field strengths from fixed RF transmitters, as determined by an electromagnetic site survey ¹ , should be less than the compliance level in each frequency range. ² Interference may occur in the vicinity of equipment marked with the following symbol: 
Radiated RF IEC 61000-4-3	3 V/m 80MHz to 2.5GHz	3 V/m	

Note 1 At 80MHz and 800MHz, the higher frequency range applies.

Note 2 These guide lines may not apply in all situations. Electromagnetic propagation is affected by absorption and reflection from structures, objects and people.

¹ Field strengths from fixed transmitters, such as base stations (cellular / cordless) telephones and land mobile radios, amateur radio, AM and FM radio broadcast and TV broadcast cannot be predicted theoretically with accuracy. To assess the electromagnetic environment due to fixed RF transmitters, an electromagnetic site survey should be considered. If the measured field strength in the location in which the Keeler Pulsair IntelliPuff is used exceeds the applicable RF compliance level above, the Keeler Pulsair IntelliPuff should be observed to verify normal operation. If abnormal performance is observed, additional measures may be necessary, such as re-orientating or relocating the Keeler Pulsair IntelliPuff.

² Over the frequency range 150kHz to 80 MHz, field strengths should be less than 3 V/m.

16. Specifications and electrical ratings

Recommended separation distances between portable and mobile RF communications equipment and the Keeler Pulsair IntelliPuff

The Keeler Pulsair IntelliPuff is intended for the use in an electromagnetic environment in which radiated RF disturbances are controlled. The customer or the user of the Keeler Pulsair IntelliPuff can help prevent electromagnetic interference by maintaining a minimum distance between portable and mobile RF communications equipment (transmitters) and the Keeler Pulsair IntelliPuff as recommended below, according to the maximum output power of the communications equipment.

Rated maximum output power of transmitter W	Separation distance according to frequency of transmitter m		
	50 kHz to 80MHz	80MHz to 800MHz	800MHz to 2.5GHz
	$d = 1.2\sqrt{p}$	$d = 1.2\sqrt{p}$	$d = 2.3\sqrt{p}$
0.01	0.12	0.12	0.23
0.1	0.38	0.38	0.74
1	1.2	1.2	2.3
10	3.8	3.8	7.3
100	12	12	23

For transmitters rated at a maximum output power not listed above, the recommended separation distance d in metres (m) can be determined using the equation applicable to the frequency of the transmitter, where p is the maximum output power rating of the transmitter in watts (W) according to the transmitter manufacturer.

Note 1 At 80MHz and 800MHz, the separation distance for the higher frequency applies.

Note 2 These guidelines may not apply in all situations. Electromagnetic propagation is affected by absorption and reflection from structures, objects and people.

17. Accessories and warranty

Accessories supplied

Dust cover

Printer paper

Puff tube dust cap

Wall mounting bracket

Quick user guide/pull out card

Consumable

Printer paper

Pulsair warranty

The Pulsair IntelliPuff and its components are covered by warranty that they meet their performance standards and are free from any defects in materials or workmanship. Within 2 years from delivery by Keeler, the manufacturer shall at no charge to the customer, upon written notice from the customer, repair or replace any components which are defective in material or workmanship.

The customer agrees that it shall have no remedy in the event of any breach of the foregoing warranty other than as provided above. This warranty is exclusive and in lieu of all other warranties, expressed or implied, and all implied warranties of merchantability or fitness for a particular purpose are expressly disclaimed.

The obligations of the manufacturer as set forth in this warranty are expressly conditioned on the following:-

(i) No alterations or repairs of any malfunction of the system shall be made to the system except by the manufacturer or his authorized representative, without the prior written approval of the manufacturer or his authorized representative (and in no case will the manufacturer assume responsibility for repairs or alterations made by those other than the manufacturer or his authorized representative).

And (ii) The customer shall give notice to the manufacturer or their authorized representative of any malfunction of the system and shall not use the system for any diagnostic purpose thereafter.

The logo for Keeler, featuring the word "Keeler" in a bold, blue, sans-serif font.

18. Contact, packaging and disposal information

Manufacturer

Keeler Limited
Clewer Hill Road
Windsor
Berkshire
SL4 4AA

Freephone: 0800 521251
Tel: +44 (0) 1753 857177
Fax: +44 (0) 1753 827145

USA Sales Office

Keeler Instruments Inc
3222 Phoenixville Pike
Building #50
Malvern, PA 19355
USA

Toll Free: 1 800 523 5620
Tel: 1 610 353 4350
Fax: 1 610 353 7814

Disposal of old Electrical and Electronic Equipment

(Applicable in the European Union and other European Countries with separate Collection Systems).



This Symbol on the Product or on its Packaging and instructions indicates that it was put on the market place after August 2005 and that this product shall not be treated as Household Waste.

To Reduce the Environmental impact of WEEE (Waste Electrical Electronic Equipment) and minimise the volume of WEEE entering landfills we encourage at Product end of life that this Equipment is recycled and reused.

If you need more information on the collection reuse and recycling then please contact B2B Compliance on 01691 676124 (+44 1691 676124).

 0088 EP59-70004 Issue F

